

REMOTE SOUND SYSTEM



Remote Sound System™ Installation Manual

Visit the Merit Industries, Inc. Web site
<http://www.meritind.com>



merit industries, inc.

PM0397-02

Table of Contents

Description.....	p. 1
Site Preparation.....	p. 1
Sound Zones	p. 1
Planning the Installation.....	p. 1
Installation	p. 7
Connecting the Remote Sound System to a MegaTunes™ Unit or Megatouch Combo Jukebox™	p. 7
Installing Speakers	p. 7
Connecting Speakers.....	p. 8
Replacement Parts List.....	p. 9

Description

The Remote Sound System™ includes an amplifier, subwoofer, (2) satellite speakers, (2) 50-foot lengths of speaker wire, and an RCA stereo cable. The cabinet housing the amplifier and subwoofer measures 26 1/2" H X 23" W X 23" D and is equipped with a door allowing access to the components inside (see Figure 1).

Site Preparation

In determining the location for your Remote Sound System™, keep in mind that it must be connected to a suitable, grounded electrical outlet. As a basic guideline, never connect the sound system to a circuit that also supplies power to freezers, coolers or other high power-consuming and electrical noise-generating equipment. Familiarity with standard wiring practices, as recognized by a government agency in your area, is necessary.

Make sure the unit is not exposed to any moisture or excessive heat and that there is enough space to ensure proper ventilation. The unit should also be located on a sturdy, level surface.

Sound Zones

A sound zone is considered to be any set of speakers that are controlled as a single unit. A single set of speakers with the same volume control would be configured as ZONE 1, with an additional speaker set configured as ZONE 2.

Planning the Installation

Consider the following as you decide on speaker placement:

- volume required in the area
- the stereo image. The sound stage of sound zones can vary depending on speaker placement.

NOTE: Sometimes the physical layout of a location makes it almost impossible to create a good stereo image. For example, if a location has many small interconnected rooms or if a location is very long and narrow. Under these circumstances, it may be more advantageous to operate all speakers in mono. This would enable you to cover small rooms with one speaker instead of two and make placement much easier to determine.

See Figures 2-5 for help with laying out the sound system. Keep in mind that you will need to supply any additional cabling necessary for the desired speaker layout.

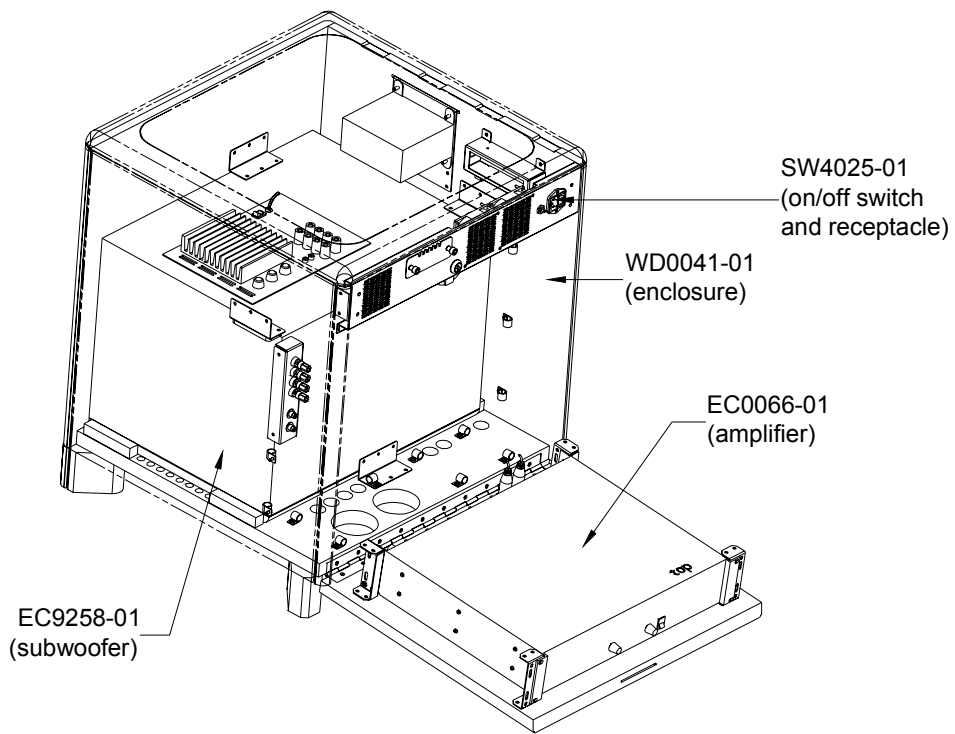

FIGURE 1 - REMOTE SOUND SYSTEM CABINET

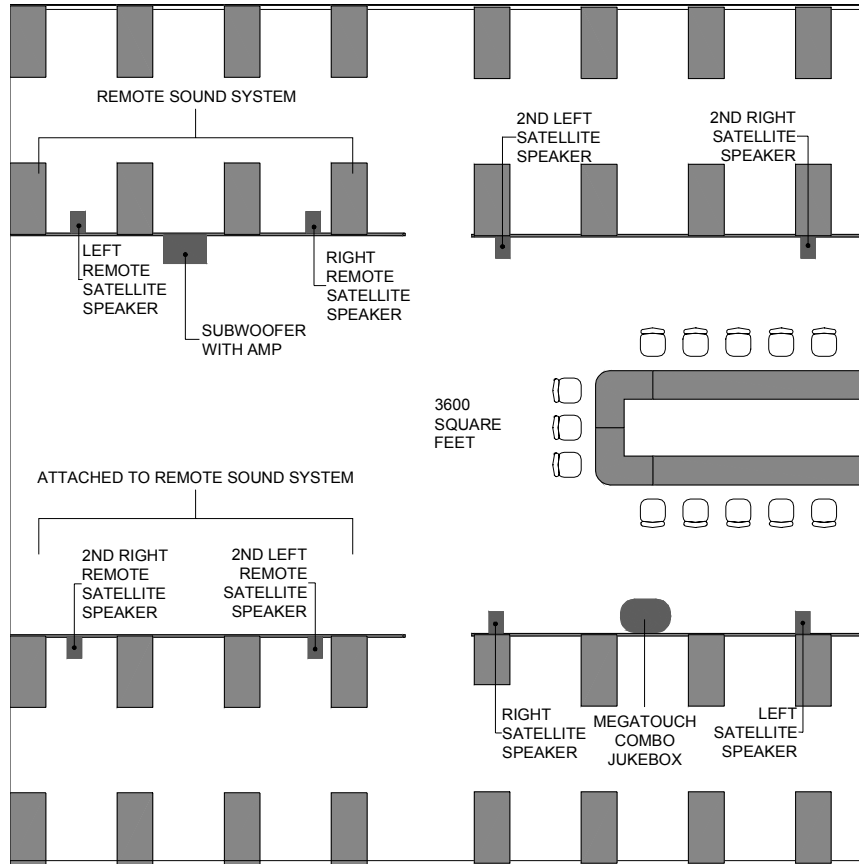

FIGURE 2 - BAR/RESTAURANT SOUND SYSTEM LAYOUT

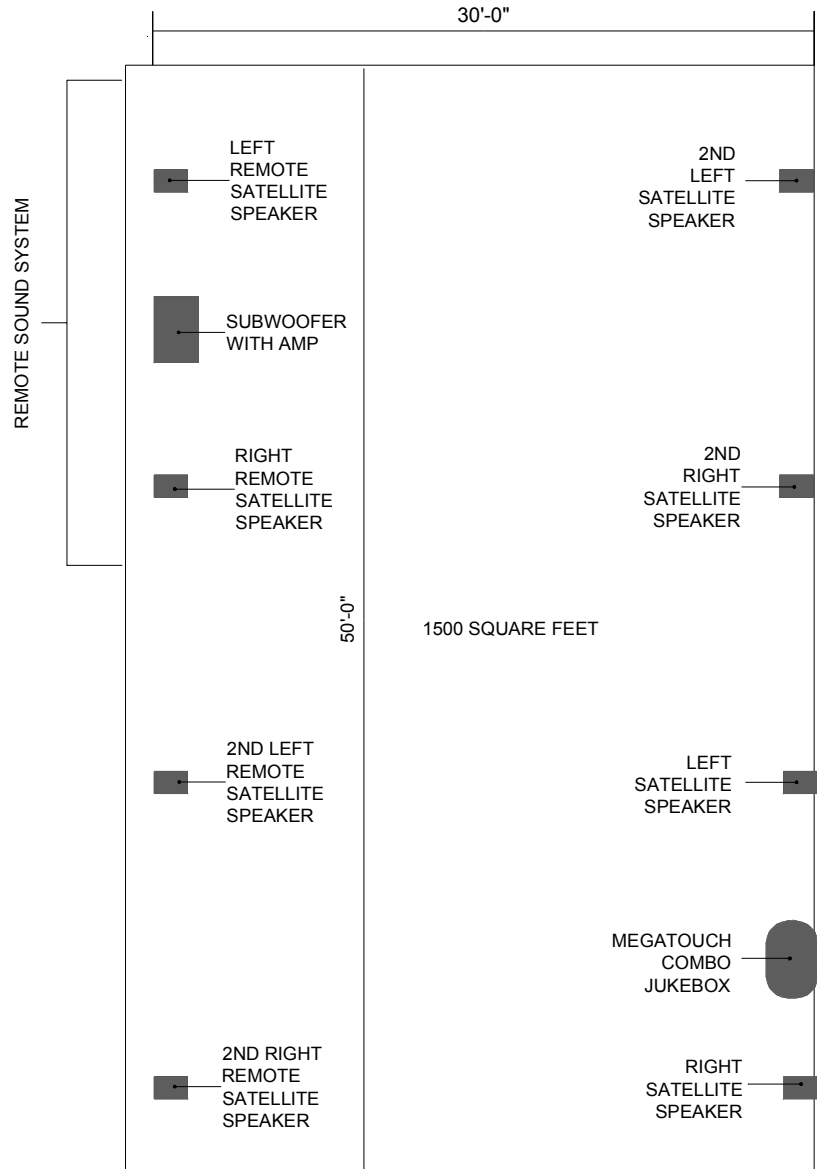

FIGURE 3 - LARGE RECTANGLE ROOM (1) SOUND SYSTEM LAYOUT

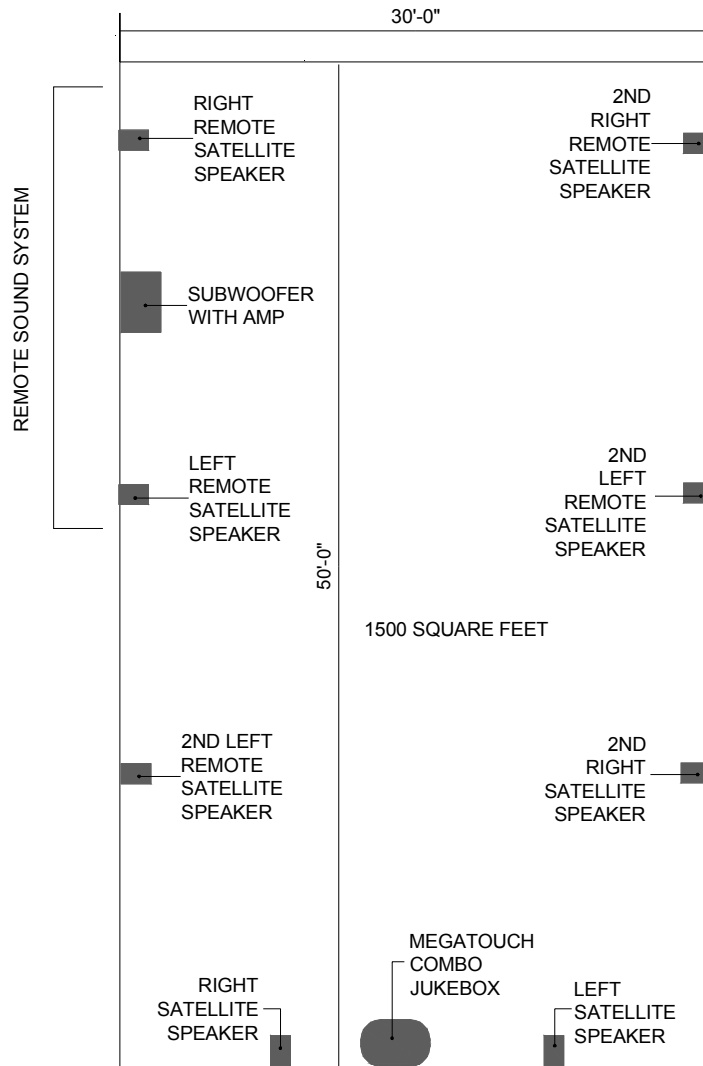

FIGURE 4 - LARGE RECTANGLE ROOM (2) SOUND SYSTEM LAYOUT

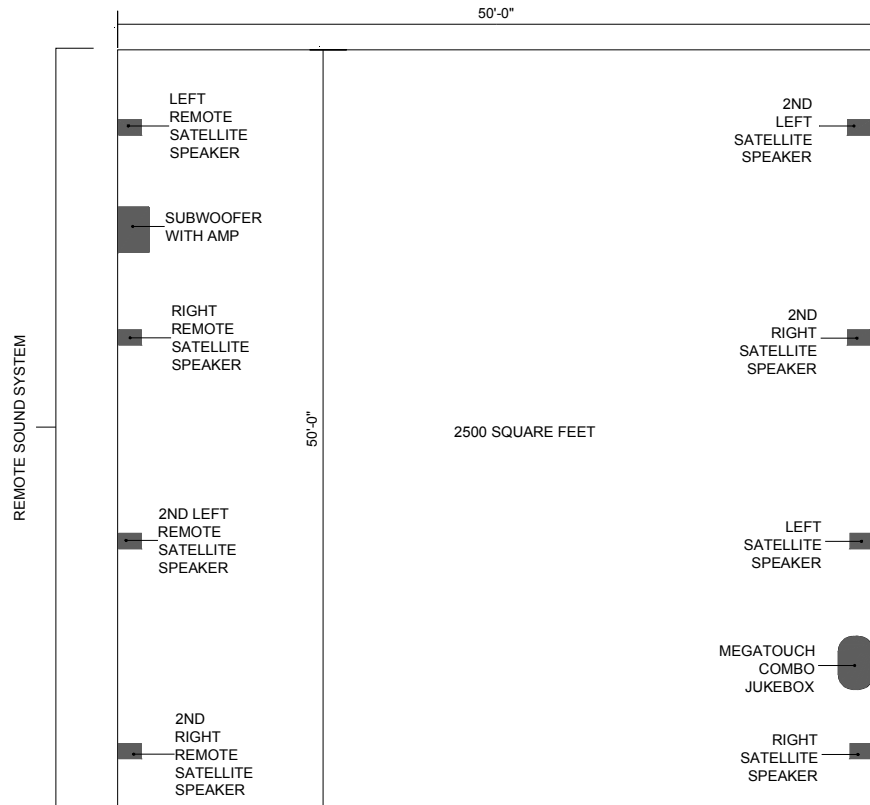

FIGURE 5 - LARGE SQUARE ROOM SOUND SYSTEM LAYOUT

Installation

Once you've selected a suitable location, you are ready to install the Remote Sound System™.

Connecting the Remote Sound System to a MegaTunes™ Unit or Megatouch Combo Jukebox™

1. Connect one end of the supplied RCA connectors (white to left, red to right) to the left and right stereo inputs on

the Remote Sound System™ cabinet (see Figure 6).

2. Connect the other end of the supplied RCA connectors to the left and right ZONE 1 (or ZONE 2 if you already have one sound system connected) outputs on the Single Board Computer inside the Megatunes™ unit or Megatouch Combo Jukebox™ (see Figure 7).

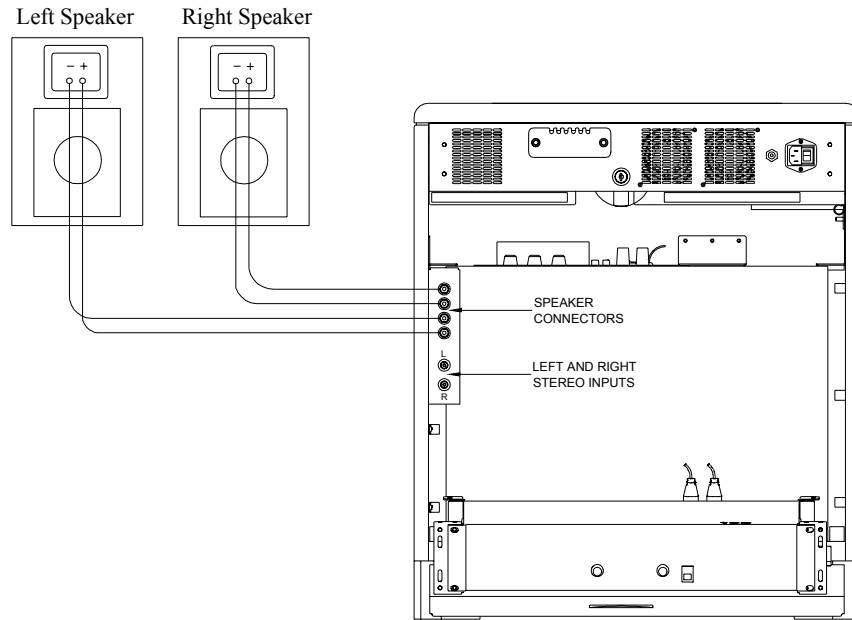

FIGURE 6 - REMOTE SOUND SYSTEM AUDIO CONNECTIONS

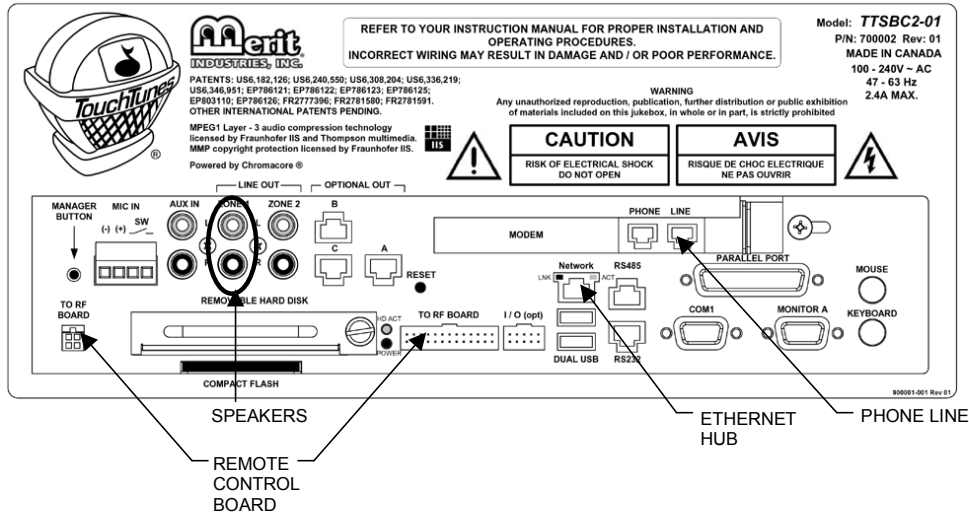

FIGURE 7 - SINGLE BOARD COMPUTER CONNECTIONS

Installing Speakers

Follow the instructions below to install the (2) supplied speakers once you've decided on an appropriate location.

NOTE: The supplied speakers will be configured as ZONE 1 in the TouchTunes® software if you do not have an existing sound system connected, or ZONE 2 otherwise.

Connecting Speakers

3. Connect one end of a length of speaker wire to the input terminals on one of the speakers and take note which sides of the wire are connected to the (+) and (-) connectors. See Figure 6.

4. Connect the other end of the speaker wire to the cabinet so the (+) and (-) speaker connectors run to the red and black connectors on the cabinet, respectively. See Figure 6.

NOTE: To avoid short-outs, make sure all strands of the exposed wire are properly connected to the speakers and subwoofer.

5. Repeat steps 3-4 to connect the other speaker.
6. Plug in and turn on the Remote Sound System.

Remote Sound System Parts List

QTY	PART NUMBER	DESCRIPTION
1	WD0041-01	REMOTE SOUND SYSTEM ENCLOSURE
1	EC9258-01	12" SUBWOOFER
1	EC0066-01	250W AMPLIFIER
2	EC9259-01	200W SPEAKER
2	WR0003-02	50' SPEAKER WIRE
1	EC0081-01	2000MM RCA CONNECTOR

For additional assistance, after contacting your distributor, contact:

TouchTunes® Technical Support

1-888-711-JUKE (5853)

Merit Product Support and Services

USA and Canada call toll-free:

1-800-445-9353

Outside the USA and Canada call:

(215) 639-4700

FAX: (215) 639-5346

Merit Industries, Inc. P.O. Box 5004, Bensalem, PA 19020-8529.

You can also visit our Web site

www.meritind.com

REMOTE SOUND SYSTEM INSTALLATION MANUAL
PM0397-02